

INSTRUCTION FOR USE AND MAINTENANCE

COOLING PLATES



Instructions for use and maintenance

In compliance with European Directives

CE

The manufacturer assumes no responsibility for any modifications or technical changes in content or data contained in this user guide. This user guide applies to all cooling equipment supplied by Gastro Production Ltd.

Contents

1. Introduction.....	1
1.1 Orientation in the user guide	1
1.2 Explanation of symbols used in the user guide	2
2. Common Provisions	3
2.1 Transport and Unpacking.....	3
2.1.1 Transport	3
2.1.2 Unpacking	3
2.1.3 Dismantling and Disposal	3
2.2 Test protocols, Warranty Conditions	4
2.2.1 Testing.....	4
2.2.2 Warranty	4
2.3.1 Safety - electric current.....	5
2.3.2 Safety - mechanics	6
2.3.3 Safety - leaking substances.....	6
2.3.4 Safety - thermal effects.....	7
2.3.5 Safety - The refrigerants R290 and R600.....	7
2.3.6 Proper use of Equipment.....	7
COOLING PLATES	9
3. Technical Features	9
3.1 Technical Description.....	9
3.2 Dimensions and Weight	10
3.3 Type Labels	10
3.4 Technical Specifications of cooling plate.....	10
4. Installation and Operation.....	11
4.1 Setting the Equipment.....	11
4.2 Connecting to the electric network	12

4.3 Turning on the Equipment.....	12
4.4 Filling the equipment with goods.....	12
4.5 Operation of the Equipment	13
5. Electronic Control Unit.....	14
5.1 Description and Dimensions	14
5.2 Operating Mode - DIXELL.....	15
5.3 Programming Mode.....	19
6. Maintenance	19
6.1 General Safety Measures	19
6.2 Regular Maintenance	20
6.2.1 Inspection	20
6.2.1.1 Evaporator.....	20
6.2.2 Maintenance	22
7. Forbidden handling procedures	23
8. Table of possible malfunctions and their correcting.....	23
9. Inquiries.....	23
Appendix 1.....	24
Control unit – Wiring diagram.....	24
Appendix 2.....	25
Cooling Plate - Wiring diagram	25
Appendix 3.....	27
Cooling Plate - Technical drawing.....	27

1. Introduction

1.1 Orientation in the user guide

- This user guide has been designed so that the users can easily and quickly find the information necessary to manage the operation and maintenance of cooling equipment.
- The users should read the entire user guide with utmost attention and make sure they have perfectly understood all information contained in it.
- The user guide also serves for subsequent reference when needed. For this reason this user guide must be always available to the person operating the equipment.
- Searching this user guide is facilitated by the general table of contents, which allows immediately finding a specific location, and also by table of contents at the head of each section.
- In addition, next to some paragraphs, there are signs inserted to emphasize the importance of the information contained in those paragraphs, **which should be read with special attention.**

1.2 Explanation of symbols used in the user guide



Warning - Danger of electrical injury - refers to parts, where there is a danger of electrical injury. Read especially carefully.



Warning - Rotating parts - refers to parts, where there is a danger from rotating parts.



Warning – Risk of injury - refers to parts, where there is a risk of injury while touching the equipment in operation. Read especially carefully.



Warning - Important - refers to parts, where danger might occur, or to parts otherwise important. Read especially carefully.



Do not wash with pressurized water – it is forbidden to wash a part so indicated with pressurized water for risk of damaging the equipment.



Forbidden handling procedures – refers to parts, where there is a risk of damaging the equipment by handling it in a forbidden way.

2. Common Provisions

2.1 Transport and Unpacking

2.1.1 Transport

The client is obliged to check for the completeness and integrity of the packaging in which the equipment is transported, and seek compensation for potential damages caused during transport from the carrier in question. The equipment should be, if possible, transported onto the location designated for its operation in its original packaging.

2.1.2 Unpacking

After transporting the equipment on the location designated for its operation, remove all packaging.



Next remove all protective wrappings from outside and inside of the equipment. The consumer is obliged to dispose of all packaging in accordance with regulations valid in their respective countries!

2.1.3 Dismantling and Disposal

At the end of its service life, the equipment must be disposed of in accordance with regulations valid in the respective countries. The equipment contains:

- Stainless steel
- Nonferrous metals - Aluminium, Copper
- Glass
- PVC
- Methacrylate (PMMA)
- Polystyrol (PS)
- ABS
- Moplen
- Nylon
- Polyethylene
- Lubricating oil
- Coolant gas
- Polyurethane
- Electric motors
- Power supply cable, wiring material

2.2 Test protocols, Warranty Conditions

2.2.1 Testing

All equipment is factory tested in accordance with applicable laws, technical standards and government regulations. For all equipment, a test report documenting the tests performed is drawn up and kept at the factory. The equipment is sent to the customer completely ready for use. An exception is equipment placed in a more complex dispensing lines and assembled on-site.

2.2.2 Warranty



Thank you for using our products. Our company will adhere to the relevant provisions of our "Terms and Conditions" and provide you with appropriate services upon submission of the invoice. **We offer a 12-month warranty from the date of purchase (invoice issue date).**

During the warranty period, our company is responsible for free replacement parts and related services if there is a device malfunction or quality issue during proper operation.



The free services do not cover the following damages:

- Failure to provide an invoice or alteration of invoice details.
- Damage caused during transportation (it is necessary to inspect the condition of the goods upon receipt from the carrier), installation, or improper connection and handling.
- Damage to components caused by failure to provide power and voltage according to the specifications in the technical data.
- Damage caused by disassembly of the products, modification, or alteration of mechanical and electrical structures without permission.
- Damage caused by improper operation, cleaning, or maintenance.

- Non-human-caused damages such as damage caused by abnormal voltage, fire, building collapse, lightning, floods, and other natural disasters, as well as damage caused by rats and other pests.
- Failure to follow the operating instructions during use.
- Wearable and consumable parts.



If the following conditions are not met, the complaint will not be considered:

How to proceed with a complaint for the fastest resolution:

- **Product identification** – by submitting the order, invoice, or inspection label.
- **Description of the defect** – describe as thoroughly as possible why the product is being claimed.
- **Attach photos or video** (used to assess the claim resolution and possibly propose repairs and ensure spare parts needed for the repair).
- **Customer's request** for claim resolution – repair (service) / return, etc.
- **Contact person** and address where the product is located.

2.3 Safety

2.3.1 Safety - electric current

The device is factory-fitted with a connecting cord for conducting the electric current, terminating in a non-detachable plug. This plug can be plugged into an outlet with voltage system 1, N, PE ~ 230V, 50Hz (an EURO socket with protective pin, a SHUKO socket with protective contacts).



Only qualified electricians are allowed to exchange the plug. The wiring of the equipment can be handled only by persons possessing electrotechnical qualification and only after the manufacturer's approval. Interfering with the wiring is dangerous to life and may cause electric injury!



It is forbidden to touch the power supply cord plug, the control panel and other electrical components with moist or wet hands, or to wash them with pressurized water. There is a danger of electric injury!



Before carrying out maintenance work, it is necessary to pull the power supply cord plug and to make sure no electric current is flowing through the equipment (e.g. by turning on the main power switch and observing if the equipment remains powered off). If the equipment is connected permanently to the mains, it is necessary to turn off the corresponding circuit breaker, make sure the equipment is not functioning and secure the deactivated circuit breaker, e.g. by putting an “equipment under maintenance” sign on it.

2.3.2 Safety - mechanics

While operating the equipment, special caution is necessary during following operations:

- When opening the blinds covering the condenser. When acting carelessly, there is a danger of cutting oneself at the condenser lamellas.



- During the operation of the cooling unit, do not put your fingers or other objects through the condenser fan covers, the evaporator fan covers, or other fan covers. There is a risk of limb injury from rotating fan blades.

2.3.3 Safety - leaking substances

The coolant used does not pose any health risks.

2.3.4 Safety - thermal effects



- During the operation of the cooling unit, the compressor body and the pipe ducts can reach considerably high temperatures – touching them may cause burns to the limbs.
- During the operation of the equipment, the condensate liquid evaporates from the evaporator tank. The tank and the heating bodies reach considerably high temperatures – touching them may cause burns to the limbs.

2.3.5 Safety - The refrigerants R290 and R600



We do not recommend handling the refrigerants R290 and R600 used in our cooling products. Any work involving these refrigerants should only be carried out by individuals with the necessary knowledge and qualifications. R290 is pure propane, and R600 is pure isobutane. These substances are highly flammable.

2.3.6 Proper use of Equipment



- **The equipment is designed for normal use by an adult.**
- **It is not designed for rough handling or operation by children! The operators of the equipment must be thoroughly and demonstrably trained in its operation and a user guide must be available to them.**
- **The equipment must be operated in accordance with the instructions for use. The equipment can be used only for purposes for which it is intended.**
- **Do not place the equipment next to heat sources or on places directly illuminated by sunlight.**

- **Before filling the equipment with goods, let it cool to the target temperature first.**
- **Do not place any hot or warm dishes into the refrigerated space.**
- **Do not place any acidic foods into the refrigerated space, as this may cause damage to the evaporator.**
- **Keep the refrigerated space clean.**
- **Do not leave the doors to the refrigerated space open – this reduces the equipment performance and lifetime.**
- **Regularly check the equipment and perform maintenance work according to this guide.**

COOLING PLATES

The equipment is able to operate properly under these conditions:

- Altitude up to 1000m above sea level
- Ambient temperature near the equipment in the range from 15°C to 25°C
- Relative humidity max. 60%
- The equipment is not placed in direct sunlight
- The equipment is not placed close to sources of heat (heaters, deep fryers, heating dispensing basins, frying plates, cooling units of other devices etc.)
- The equipment is not placed close to steam generating devices (heating dispensing basins, pasta heaters, convection ovens, etc.)

3. Technical Features

3.1 Technical Description

Cooling plates serve for cooling of food placed on trays, that spoil at room temperature. These plates are not permitted to be used for other purposes without express permission and eventual structural changes by Gastro Production s.r.o. Cooling plates are manufactured as static, whose upper surface is cooled by cooling ducts placed beneath the cooling zone. Three variants – Plate drop-in the topplate and it can be removable, Underglued plate can't be removable and Underglued-demountable plate is screwed under the topplate and it can be removable.

These cooling plates have been designed for best results provided that all instructions contained in this user guide are followed. For the plates to be used in the best way possible and to be always kept in perfect condition, we recommend that you perform the maintenance work regularly. The personnel operating the cooling plates must be necessarily familiarised with instructions regarding to operation, maintenance and safety, as contained in this user guide.



The temperature of the refrigerated space is adjustable **from 2°C to 5°C**. The temperature of the refrigerated space is maintained by an electronic control unit. The electronic control unit automatically manages the process of cooling the refrigerated space. The defrosting of the plate is performed by turning the equipment off. The resulting condensate liquid must be wiped off with a rag.

3.2 Dimensions and Weight

Dimensions and weight of the equipment can be found according to the type of equipment at www.gastro.cz.

3.3 Type Labels

The type label is placed on the inner side of the cooling unit chamber. Illustrative example.

		www.gastro.cz		CZ	
					
No :	C.0001.02.15			Type :	
Cooling perform. :	0,28 kcal/h	ΔT	-25 °C		
Input P :	0,52 kW				
Voltage system :	1,N,PE ~ 230V,50Hz				
Current load Iv :		2,9	A		
Weight :		kg	Climatic class "N"		
Refriger.:	R404a	Amount	0,5	kg	

3.4 Technical Specifications of cooling plate

	<i>1GN</i>	<i>2GN</i>	<i>3GN</i>	<i>4GN</i>	<i>5GN</i>	<i>6GN</i>
Temperature	+2°C ~ +5°C					
Cooling gas	R600	R600	R600	R290	R290	R290
Power output at T - 10°C	0,13kW	0,17kW	0,28kW	0,35kW	0,35kW	0,42kW
Power input	0,1kW	0,15kW	0,22kW	0,24kW	0,24kW	0,28kW
Voltage	1, N, PE~230V,50Hz					

4. Installation and Operation

4.1 Setting the Equipment



Always proceed carefully and slowly when handling the equipment to avoid damage or injury! Consider the weight of the equipment. Ideally, four people are required to handle the equipment. After unpacking, place the equipment in a horizontal position at the designated location. For equipment with an aggregate, it is essential to ensure that it is not damaged.

Before inserting the equipment, make sure the area around the opening designated for installation is free of debris. Slowly and carefully insert the device into the prepared opening. You can use a temporary carrier made of sturdy straps, ropes, or planks, depending on the available movement and the size of the room.

A seal is included with the product to prevent any leaks of cold air and moisture. Check that everything fits securely on the surface and is stable. Once confirmed, you can turn on the device.



Warning! Ensure that the equipment is positioned so that the condenser is accessible, as it needs to be cleaned regularly. When installing the equipment into custom furniture, ensure that there is adequate airflow at the level of the unit through perforations in the furniture.

4.2 Connecting to the electric network

The device is factory-fitted with a connecting cord for conducting the electric current, terminating in a non-detachable plug. This plug can be plugged into an outlet with voltage system 1, N, PE ~ 230V, 50Hz (an EURO socket with protective pin, a SHUKO socket with protective contacts). Insert the plug of the connecting cord into the outlet. Ensure that the plug remains accessible to the operator. The cord cable must be laid out visibly and without any sharp bends. The cord cable must not be laid out across sharp edges of any sheet metal or other components.

4.3 Turning on the Equipment



After positioning the equipment, wait at least 30 minutes before turning it on. During the winter months, wait 12 hours at room temperature.

Turn on the equipment by setting the main power switch to **position 1**. **The indicator light should come on.** For setting the temperature of the refrigerated space on the electronic control unit, refer to section 5.

4.4 Filling the equipment with goods

After the refrigerated space reaches the target temperature, you may fill it with goods. **Please follow the principles of proper use of equipment outlined.**



Do not place any hot or warm dishes into the refrigerated space.

Do not place any acidic foods into the refrigerated space, as this may cause damage to the evaporator.

4.5 Operation of the Equipment



- **Keep the refrigerated space clean.**
- **Regularly check the equipment and perform maintenance work according to section 6 of this user guide.**

5. Electronic Control Unit

The Cooling equipment is controlled by DIXELL. The Cooling equipment can be controlled by a DANFOSS thermostatic valve that controls the temperatures. Based on this data, it lets in warm or cooled air. The manufacturer takes no responsibility for any equipment malfunction resulting from interfering with the electronic control unit settings. This provision does not apply to settings permitted by this user guide

For proper cooling function and condensation evaporation from the evaporator tray, the product needs to be set to 'stand-by' mode. This can be done as follows:

- **Press the lower right button to turn the 'stand-by' mode on/off.**
- **Display shows 'OFF' / after turning on, the temperature value (...°C) will appear on the control unit display.**

5.1 Description and Dimensions

DIXELLS are electronic thermostats with passive defrosting. They are fitted with a microprocessor and are suitable for refrigeration applications at normal temperatures. They are suitable for mounting on panels and their dimensions are 32x74 mm. They have one, two or three relay outputs to control compressor, fan, defrosting, lighting. It is possible to connect up to three PTC or NTC sensors to them.

Technical parameters

Wrapping: **self-extinguishing plastic ABS**

Case: **front panel: 32 x 74mm, depth: 60mm**

Mounting: **into the panel with cut-out aperture of 71 x 29mm**

Front panel cover: **IP65**

Attachment: **barrier strip for conductors with up to 2.5mm² cross section.**

Supply voltage: **230V~, ±10%; 50, 60Hz**

Input power: **3VA max**

Data memory: **EEPROM**

Working temperature range: **0 to 60°C**

Temperature range for storage: **-30 to 85°C**

Relative humidity: **20 to 85%**



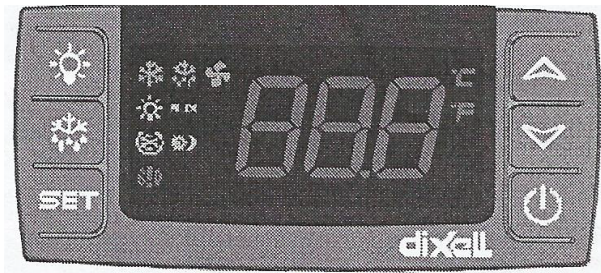

Accuracy (at ambient temperature of 25°C): **±0,7°C±1 digit**

5.2 Operating Mode - DIXELL





FRONT PANEL COMMANDS:









Button description

SET	Displays the desired value. In programming mode serves for selecting a parameter or confirming an operation.
	(UP) : Displays maximum temperature recorded. In programming mode serves for navigating the parameter list and increasing the displayed value.
	(DOWN) : Displays minimum temperature recorded. In programming mode serves for navigating the parameter list and decreasing the displayed value.
	Turns the device on and off.
	Turns the lighting on and off, if available.
	(DEF) : Initiates manual defrost.



Key combinations

 	Locks and unlocks the keyboard.
SET 	Enters the programming mode.
SET 	Returns to displaying the value of the refrigerated space temperature.



Explanation of LED functions

	<i>Lit up - Compressor running</i> <i>Flashing - Compressor minimum cycle delay</i>
	<i>Lit up - Defrosting in progress</i> <i>Flashing - Dripping in progress</i>
	<i>Lit up - Fans running</i> <i>Flashing - There is a time delay for the fans to switch on during defrost</i>
	<i>Lit up - Alarm</i>
	<i>Lit up - A continuous cooling cycle is in progress</i>
	<i>Lit up - Energy saving cycle</i>
°C / F	<i>Lit up - Measured units</i> <i>Flashing - Programming mode</i>

Displaying minimum recorded temperature

1. Press the  button.
2. A "Lo" message appears on the display followed by minimum recorded temperature.
3. After another pressing of the  button or a 5s wait the device returns to normal mode of operation displaying the measured temperature.

Displaying maximum recorded temperature

1. Press the  button.
2. A "Hi" message appears on the display followed by maximum recorded temperature.
3. After another pressing of the  button or a 5s wait the device returns to normal mode of operation displaying the measured temperature.

Resetting the recorded MIN. / MAX. temperatures



1. While viewing either of the MIN. / MAX. temperatures, press the **SET** button for more than 3s, until the "rSt" message appears.
2. Confirm the operation by again pressing the **SET** button. The "rSt" starts flashing. The device resumes displaying the current temperature.

MAIN FUNCTIONS

Displaying the Target Temperature

1. Shortly press the **SET** button. The device displays the target temperature.
2. To again display the current temperature, shortly press the **SET** button again or wait 5s.



Setting the Target Temperature

1. Hold the **SET** button for more than 2s.
2. The device starts displaying the target temperature and the °C warning light starts flashing.
3. The target temperature can be adjusted by pressing the  or  buttons (within 10s interval).
4. The new target temperature is confirmed either by again pressing the **SET** button or automatically after 10s interval.



Initiating Manual Defrost

1. Press and hold the  for more than 2s.



Locking the Keyboard

1. Hold the  +  buttons simultaneously for at least 3s.
2. The **"POF"** message appears and the keyboard is locked. Now it is only possible to see the target temperature or the MIN. / MAX. recorded temperature.
3. Upon pressing any key for more than 3s, the **"POF"** message appears.



Unlocking the Keyboard again

1. Hold the  +  buttons simultaneously for at least 3s, until the **"PON"** message appears.

The Continuous Cycle

1. Unless there is defrost in progress, it is possible to initiate the continuous cycle by pressing the  button for more than 3s. The compressor enters the continuous cycle and operates to maintain the CCS setpoint for the time set through the CCt parameter. The cycle can be terminated before the end of the set time by pressing the  button for more than 3s.

The ON/OFF Function

1. The device can be turned off by pressing the  button. The **"OFF"** message appears. In this configuration, the regulation is disabled. To switch the controller on, again press the  button.

WARNING! - Loads connected to the normally closed contacts of the relays are always supplied and under voltage, even if the controller is in stand-by mode.

5.3 Programming Mode



Activating the programming mode is allowed only to servicing organisations with permission from the manufacturer.

6. Maintenance

6.1 General Safety Measures



Before commencing maintenance, study this user guide thoroughly.

Follow the instructions contained in section **2.3 Safety**.



Before carrying out maintenance work, it is necessary to pull the power supply cord plug and to make sure no electric current is flowing through the equipment (e.g. by turning on the main power switch and observing if the equipment remains powered off).

If the equipment is connected permanently to the mains, it is necessary to turn off the corresponding circuit breaker, make sure the equipment is not functioning and secure the deactivated circuit breaker, e.g. by putting an “equipment under maintenance” sign on it.

During maintenance work, proceed with caution and without haste.



- **Do not use pressurized water for washing the equipment, there is a risk of damage to ventilator fans, compressor, electronic components and to the whole equipment as a consequence!**
- To clean the equipment use a common kitchen detergent approved for use with foodstuffs!

6.2 Regular Maintenance

6.2.1 Inspection

6.2.1.1 Evaporator

- No maintenance necessary

6.2.1.2 Evaporator fans

- Not fitted.

6.2.1.3 Compressor

- Take off the covering blind of the cooling unit (*number 5 in the technical drawing in aggregate assembly*) (if it is fitted) after unscrewing the fastening screws.
- Remove any deposited dust from the compressor by vacuuming or using a compressed air blower.
- From the vicinity of the compressor, remove any undesirable material that would obstruct the free flow of air.

6.2.1.4 Condenser

- Check that there are no dust deposits or other particles on the condenser lamellas (*number 5 in the technical drawing in aggregate assembly*). **While pointing a flashlight towards the lamellas, you should be able to see through them!**
- Remove any eventual impurities with a brush or a compressed air blower.

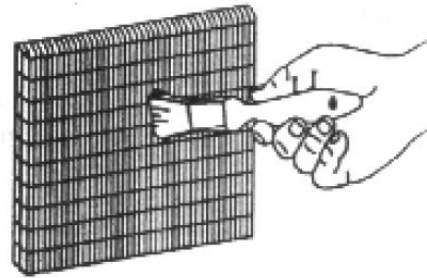
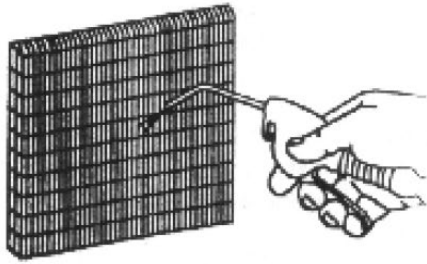

- If it is not possible to clean the condenser, contact a servicing organisation. The condenser needs to be replaced, failing to do so would result in destruction of the whole cooling unit.
- Use increased caution during cleaning, there is a danger of cutting oneself at the condenser lamellas.
- If the condenser fan is readily accessible, check manually that the fan rotates freely. If the fan is inaccessible, it is necessary to check that the fan is functioning correctly during operation, in the following way: Provided that the condenser is clean, put an A4 sheet of paper against the front side of the condenser while the cooling unit is in operation. The sheet of paper should cling firmly to it and not fall off.

6.2.1.5 Sealing surfaces

- Not fitted.

6.2.1.6 Lighting

- Not fitted.

6.2.1.7 Hinges, sliding surfaces

- Not fitted.

6.2.1.8 Ventilation apertures

- Ensure that all ventilation apertures are unobstructed and clean. Mechanically remove any eventual impurities by vacuuming or using a compressed air blower.



Never place any obstacles in front of the ventilation apertures!

6.2.2 Maintenance

6.2.2.1 Daily maintenance

- During maintenance work, follow the instructions contained in section 6.1 General Safety Measures.
- After finishing daily operation, turn off the equipment. Remove the foodstuffs from the equipment, clean the refrigerated space and wipe it dry.
- **While the equipment is turned off, perform maintenance as detailed in sections 6.2.1.1-6.2.1.8.**

6.2.2.2 Monthly maintenance

- During maintenance work, follow the instructions contained in section **6.1 General Safety Measures.**
- During monthly maintenance perform tasks detailed in sections **6.2.1 Inspection and 6.2.2.1 Daily Maintenance.**

7. Forbidden handling procedures



- **Do not use the equipment for other purposes than intended!**
- **Do not interfere with the circuitry of the equipment!**
- **Do not perform any other activities forbidden elsewhere in this user guide!**
- **Do not wash the equipment with pressurized water!**
- **Do not handle the equipment roughly!**
- **It is forbidden to operate the equipment without prior training and without having this user guide available!**

8. Table of possible malfunctions and their correcting

<i>Malfunction name</i>	<i>Control unit message</i>	<i>Possible correction method</i>
<i>Malfunctioning refrigerated space probe</i>	PF1	Replace thermal probe
<i>Malfunctioning evaporator probe</i>	not fitted	Replace thermal probe
<i>Plate not cooling</i>	HiA	Check the plate as per section 6.2 Regular Maintenance. After inspection, turn the equipment on again and let it operate for at least 60 min. If the problem persists, contact a servicing organisation.
<i>Plate cooling too much</i>	LoA	Malfunctioning control unit relay – replace the control unit

9. Inquiries

If you need help and advice, do not hesitate to contact us, and we will assist you with everything. You can find our contact information on our website www.gastro.cz.

Appendix 1

Control unit – Wiring diagram

DIXELL XR20CH

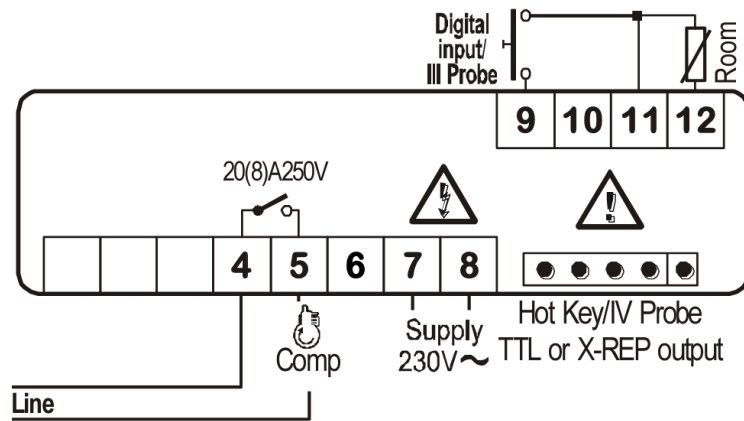

- 9-40Vdc supply:** connect to the terminals 7 and 8.
- 12Vac/dc supply:** connect to the terminals 7 and 8.
- 24Vac/dc supply:** connect to the terminals 7 and 8.
- 120Vac supply:** connect to the terminals 7 and 8.

Appendix 2

Cooling Plate - Wiring diagram

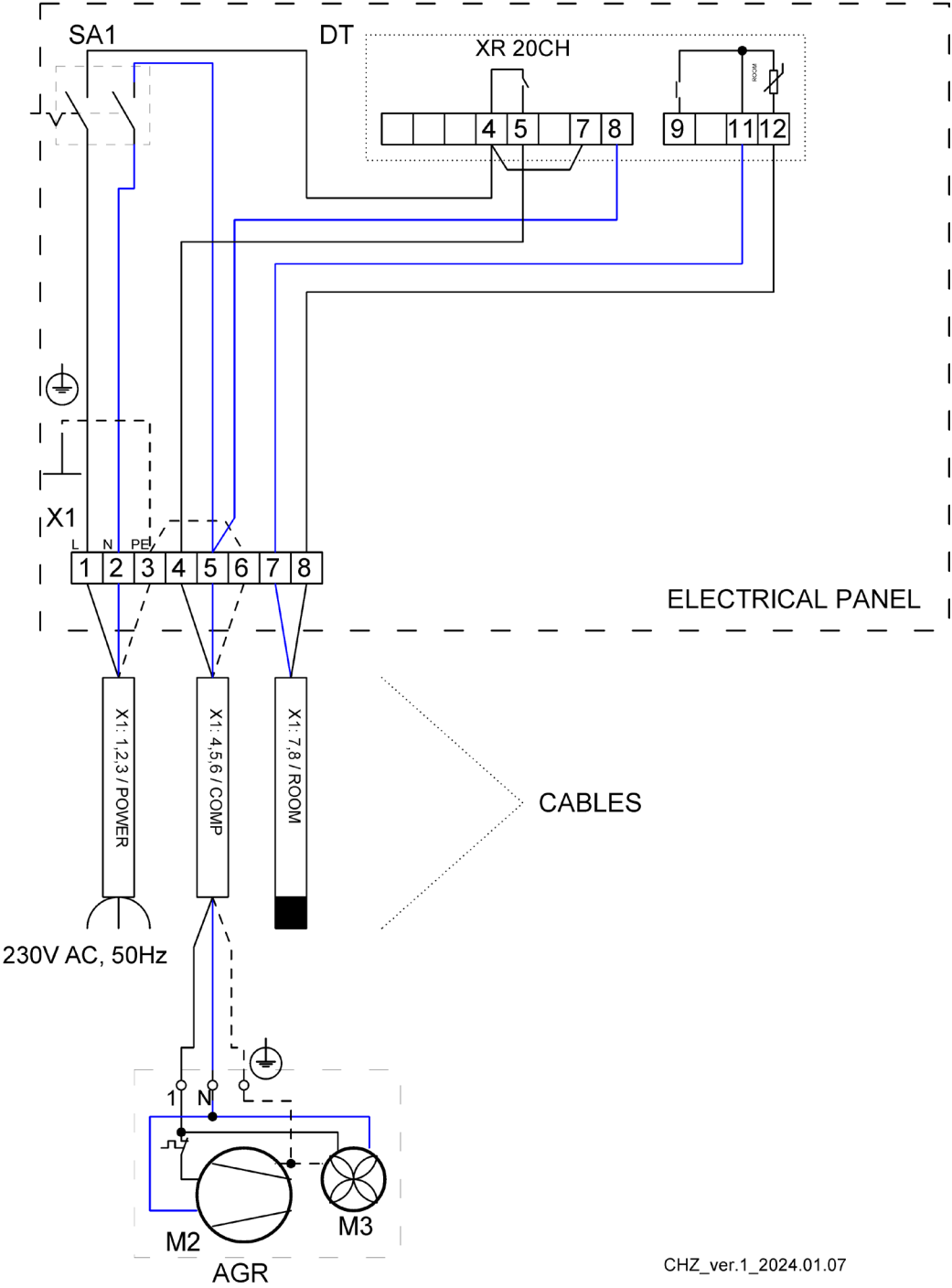

CHZ_ver.1_2024.01.07

Legend:

SA1 – Main switch

DT – Control unit

X1 – Connection terminal block

AGR – Aggregate

M2 – Compressor motor

M3 – Condenser fan motor

Appendix 3

Cooling Plate - Technical drawing

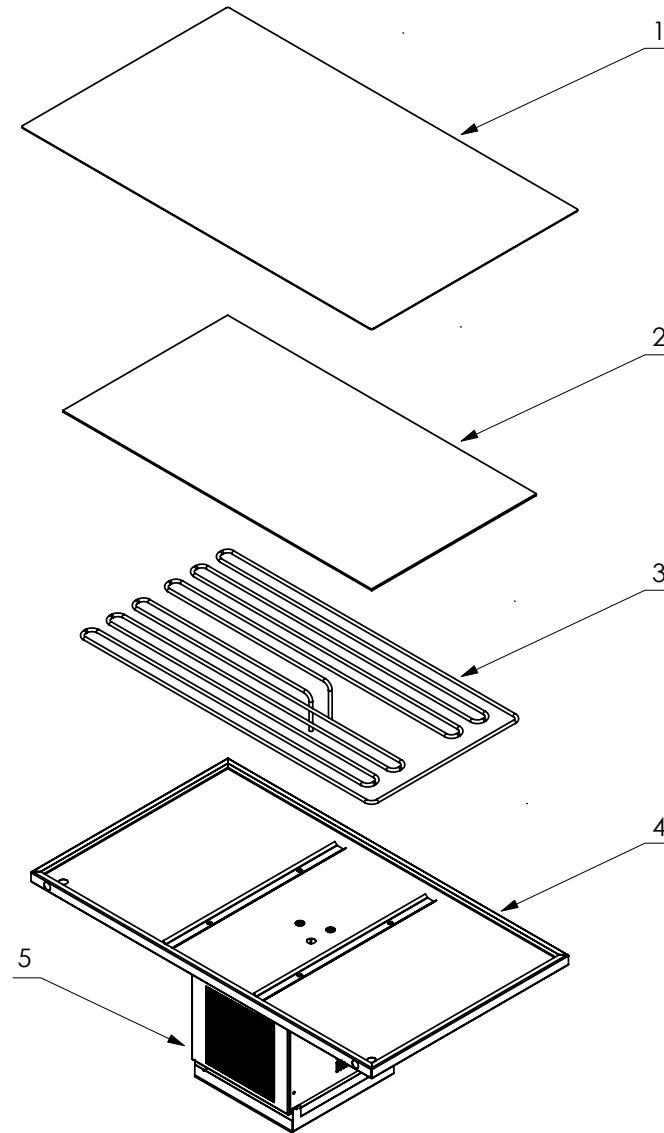

Legend:

1. Top plate
2. Body of the cooling plate
3. Cooling pipes
4. Outer cover
5. Agregate (Condenser, Compressor, refrigerant collector,...)